

# TRAPEZE PARTY HACK

This hack tells you how to add a double layered gather skirt and ribbon tie back opening to the Trapeze.

## DRESS LENGTH AT CB

116.5(117, 117.5, 118, 118.5, 119, 119.5, 120, 120.5, 121, 121.5)cm down from the CB neck. *Sizes 10 - 28 are shown in brackets.*

## FABRIC REQUIREMENTS

	GATHERED AT x 3 (with or without nap)*		GATHERED AT x 2 (with or without nap)*	
	110-120cm/43½-47" wide	140-150cm/55-60" wide	110-120cm/43½-47" wide**	140-150cm/55-60" wide***
SIZE 8	4.3M/4¾yd	3.8M/4¼yd	2.7M/3yd	2.8M/3¼yd
SIZE 10	4.4M/5yd	3.9M/4¼yd	2.8M/3¼yd	2.8M/3¼yd
SIZE 12	4.6M/5yd	4.1M/4½yd	2.9M/3¼yd	2.8M/3¼yd
SIZE 14	4.7M/5¼yd	4.2M/4¾yd	3M/3¼yd	2.8M/3¼yd
SIZE 16	4.9M5½yd	4.4M/5yd	3.1M/3½yd	2.8M/3¼yd
SIZE 18	5M/5½yd	5M/5½yd	3.2M/3½yd	2.8M/3¼yd
SIZE 20	5.4M/6yd	5.4M/6yd	4M/4½yd	3.3M/3¾yd
SIZE 22	5.6M/6¼yd	5.6M/6¼yd	4.1M/4½yd	4.1M/4½yd
SIZE 24	5.8M/6½yd	5.8M/6½yd	4.2M/4¾yd	4.2M/4¾yd
SIZE 26	6M/6¾yd	6M/6¾yd	4.3M/4¾yd	4.3M/4¾yd
SIZE 28	6.3M/7yd	6.2M/7yd	4.5M/5yd	4.4M/5yd

\*Grain runs parallel to hem.

\*\*110-120 wide, grain runs parallel to hem.

\*\*\*140-150 wide, grain runs down length of skirt with side seam.

## YOU WILL NEED

Optional: Ribbon - 2 x 50cm/20" long.

Lining for skirt: See CUTTING FORMULA - LINING on the following page. This piece can be cut on either the straight or cross grain and seamed to avoid waste.

We have bagged out the bodice in self, if you want to bag it out (line it) in lining you will need an additional quantity of lining:

110-120 wide, sizes 8-28 1M/1¼yd extra.

140-150 wide sizes 8-16 0.5M/¾yd extra.

140-150 wide sizes 18-28 1M/1¼yd extra.

# MERCHANT & MILLS

## SKIRT DIMENSIONS (includes seam allowance at hem)

The finished skirt length is 88cm. It is double layered, with a fold at the top where it is gathered onto the bodice. The grain runs parallel to the hem, to enable you to use the whole width of the fabric (unless using 140-150 wide fabric - then you will have side seams running down the skirt).

You will create a tube, with folds at the top and hem. After the tube is made, you will sew a centre back seam (more instructions to follow).

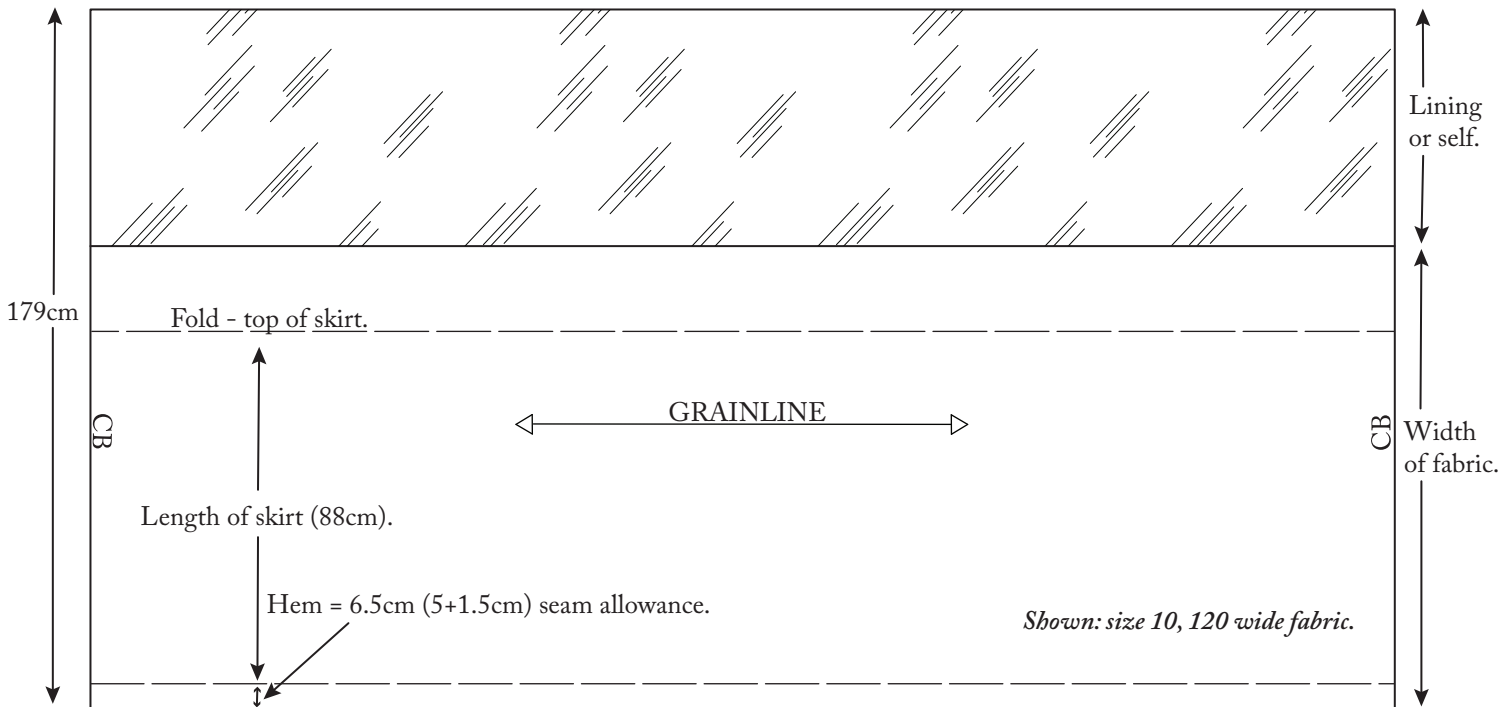

← 2 x gather, width of skirt: 211(221, 231, 241, 251, 261, 284, 297, 309, 322, 334)cm. Sizes 10-28 are shown in brackets. →  
 3 x gather, width of skirt: 318(333, 348, 363, 378, 393, 429, 448, 466, 486, 504)cm. Sizes 10-28 are shown in brackets.

## CUTTING FORMULA - SKIRT x 1

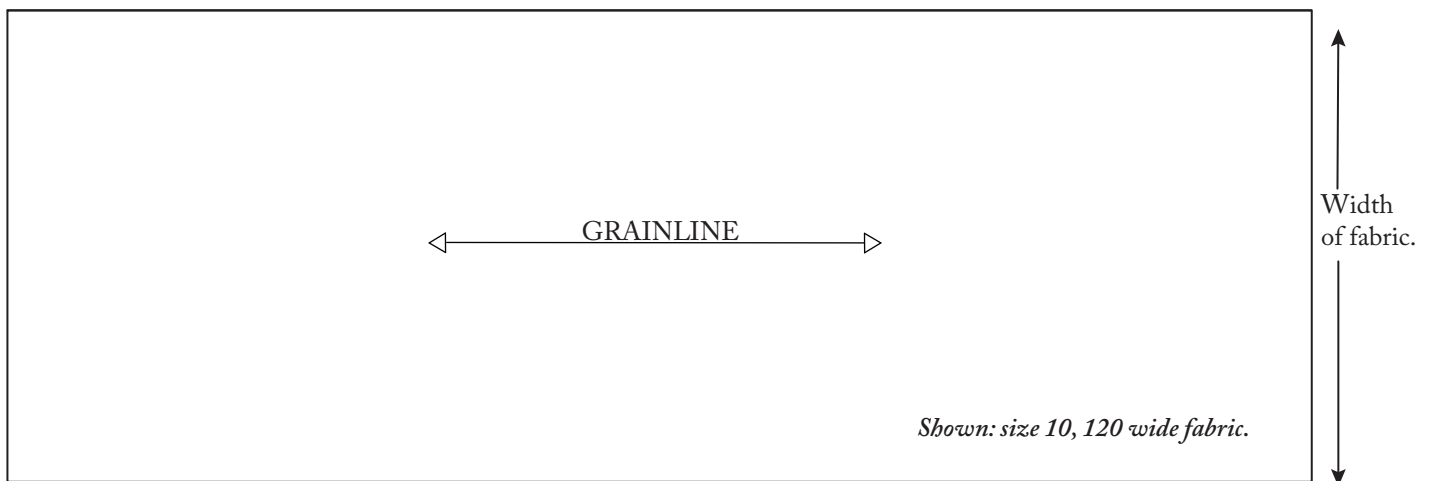

← Width of skirt 318(333, 348, 363, 378, 393, 429, 448, 466, 486, 504)cm. Sizes 10 - 28 are shown in brackets. →

## CUTTING FORMULA - LINING x 1

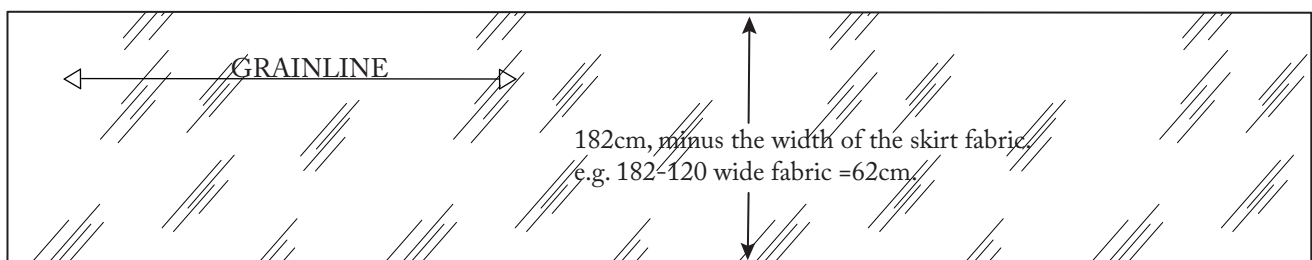

← 2 x gather, width of skirt: 211(221, 231, 241, 251, 261, 284, 297, 309, 322, 334)cm. Sizes 10-28 are shown in brackets. →  
 3 x gather, width of skirt: 318(333, 348, 363, 378, 393, 429, 448, 466, 486, 504)cm. Sizes 10-28 are shown in brackets.

## ADAPT YOUR PATTERN - BODICE

1. Trace off the FRONT (pattern piece 1 for sizes 8-18 and pattern piece 15 for sizes 20-28) and BACK (pattern piece 2 for sizes 8-18 and pattern piece 16 for sizes 20-28) bodice pattern pieces, approximately 50cm down.

*Sizes 10 - 28 are shown in brackets.*

**A & F** - Measure 15.5cm down from the armhole.

**B** - Measure 38(38.5, 39, 39.5, 40, 40.5, 42.5, 43.2, 44, 44.7, 45.5)cm down from the high neck point at the front.

**C** - Measure 30(30.5, 31, 31.5, 32, 32.5, 33, 33.5, 34, 34.5, 35)cm down from the CF neck.

**D** - Measure 32.5(33, 33.5, 34, 34.5, 35, 35.5, 36, 36.5, 37, 37.5)cm down from the CB neck.

**E** - Measure 37(37.5, 38, 38.5, 39, 39.5, 40, 40.5, 41, 41.5, 42)cm down from the high neck point at the back.

Draw a curved line between CF/CB, midpoint and side seam, making sure you start and finish with a right angle.

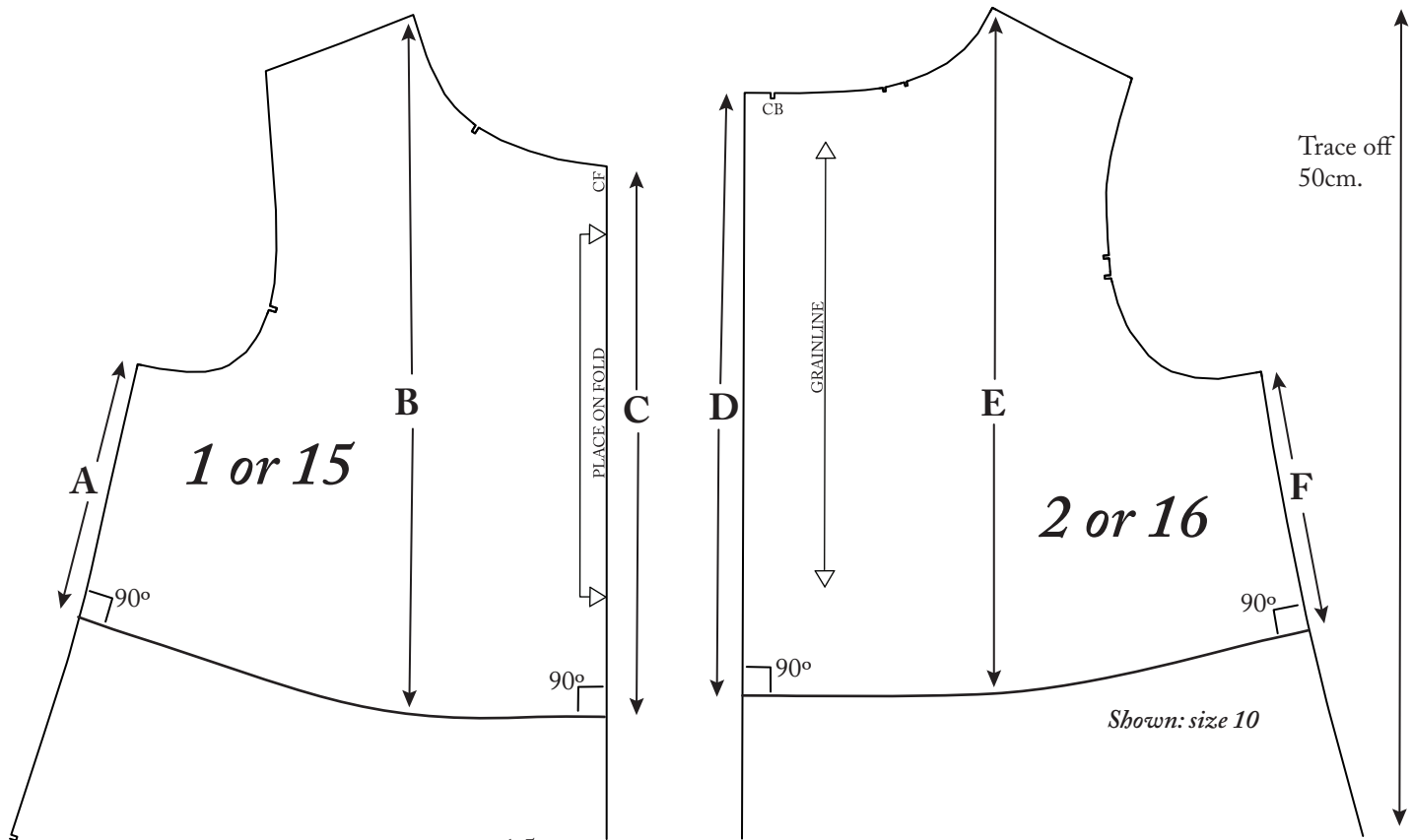

2. Mark the shoulder seam on the front and back bodice, 1.5cm away from the edge.

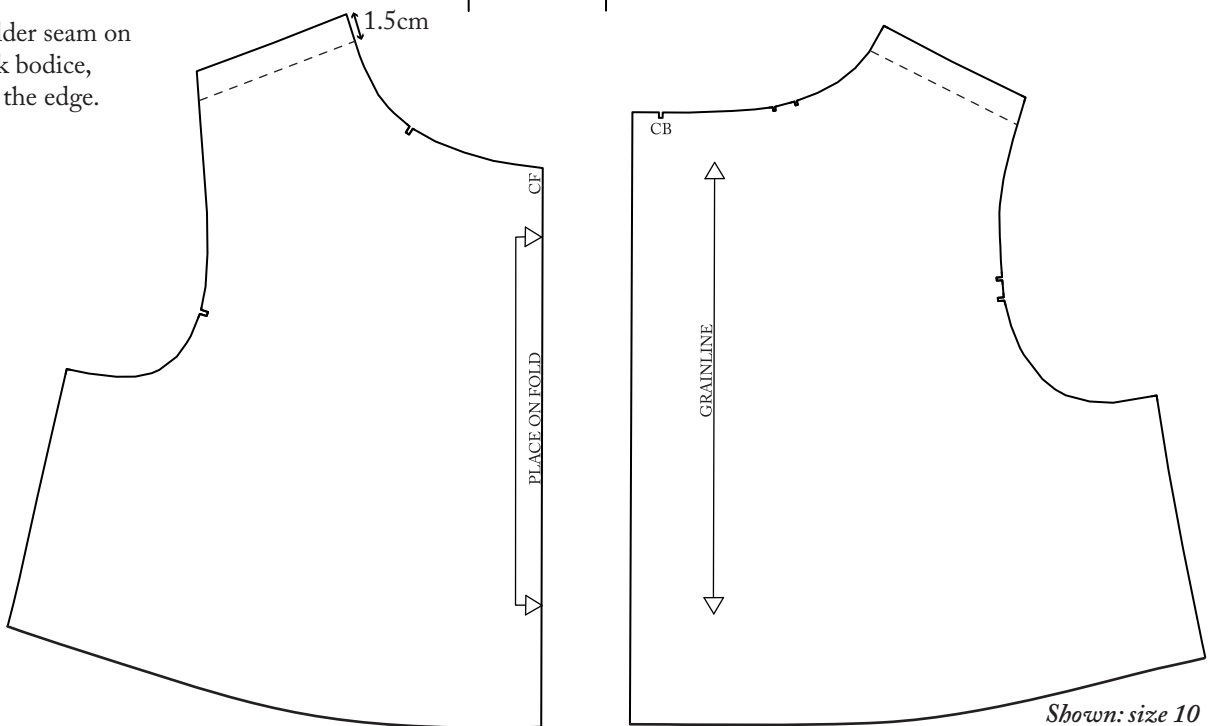

3. Overlap the two shoulder seams and pin together. Narrow the shoulder by measuring 7.2(7.5, 7.8, 8.1, 8.3, 8.7, 9.1, 9.5, 9.9, 10.3, 10.7)cm from the neck to the edge of shoulder (line **G**). *Sizes 10 - 28 are shown in brackets.*

Re-draw the new armhole shape with a curve and cut off excess. This creates your new bodice pattern pieces.

The FRONT will be CUT 2 ON FOLD or CUT 1 SELF ON FOLD & CUT 1 LINING ON FOLD.

The BACK will be CUT 4 (2 PAIRS) SELF or CUT 2 (1 PAIR SELF) & CUT 2 (1 PAIR LINING).

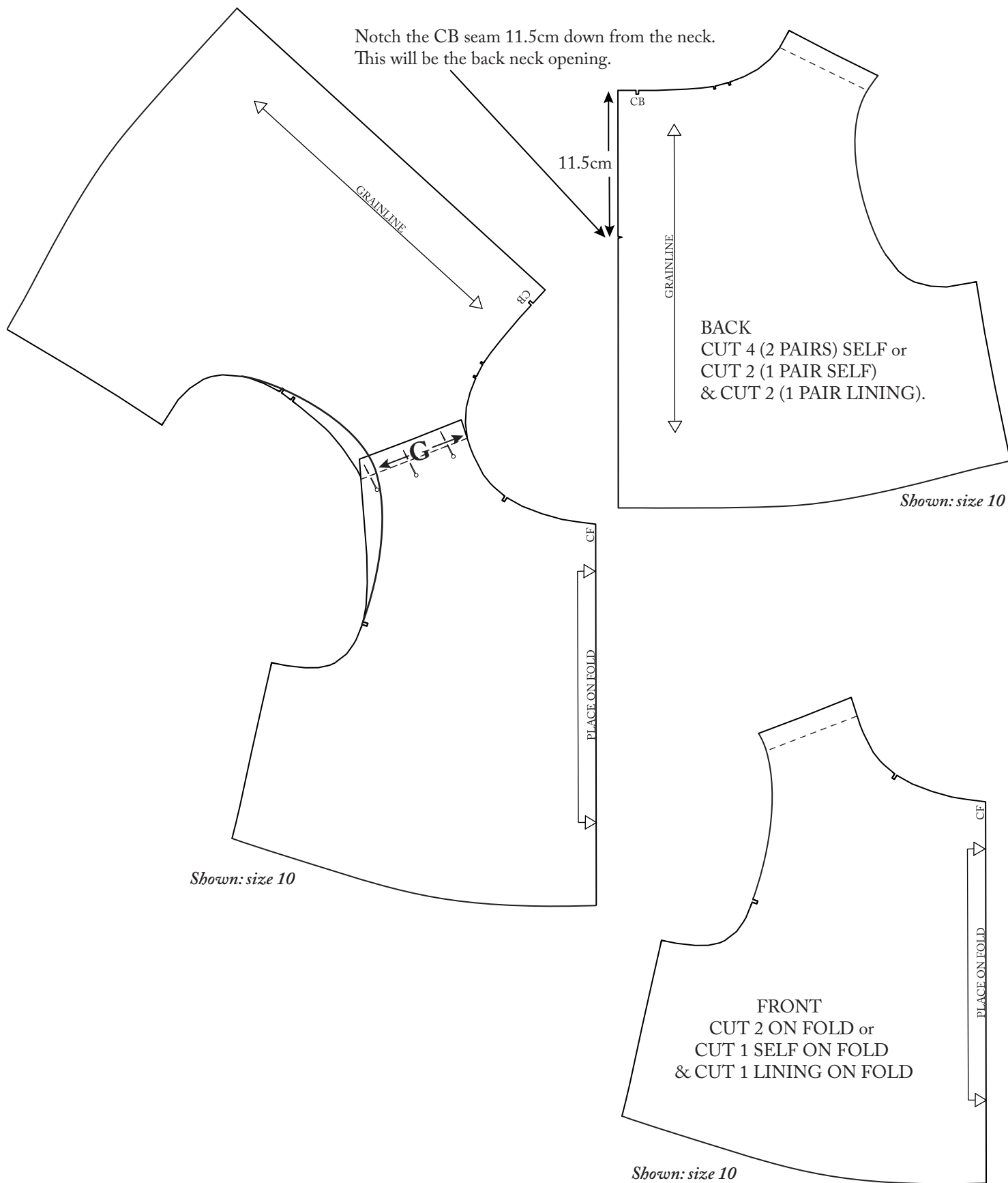

## MAKE SKIRT

4. With right sides together, stitch lining to skirt at top and bottom, using a 1.5cm seam allowance. Press seams towards the lining.

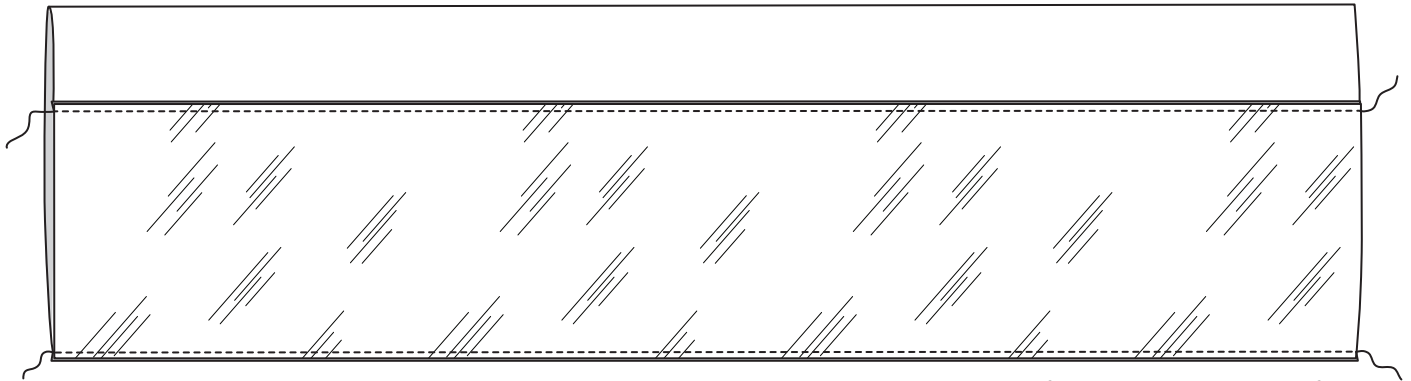

*Shown: size 10, 120 wide fabric.*

5. With right sides together and matching seams, push one end of the tube into the other. Stitch, leaving an opening of approximately 20cm to turn the skirt through. Press this seam open. (CB seam).

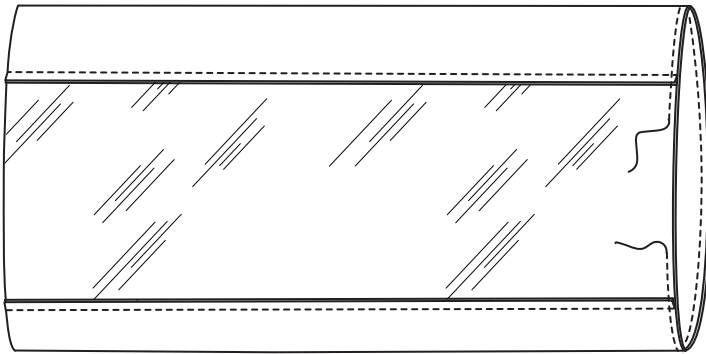

*Shown: size 10, 120 wide fabric.*

6. Bring the skirt through to the right side via the opening. Close the opening with a slip stitch, or machine edgestitch. Press the hem (5cm below the lower seam) and press the top edge where it wants to sit (now treating the double fabric as one). Tailor tack the skirt: opposite the CB is the CF. Divide the space between the CF and CB to get the side positions.

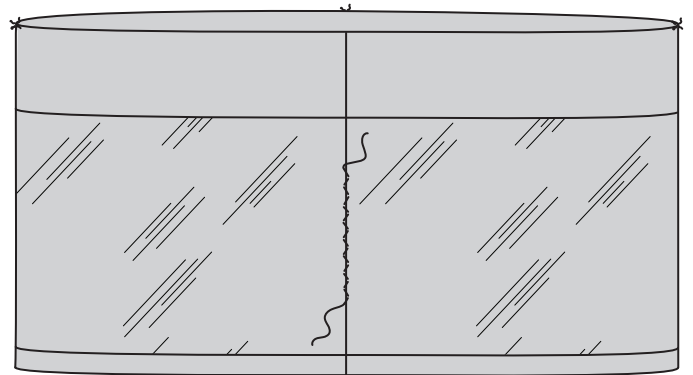

*Shown: size 10, 120 wide fabric.*

7. Work two rows of gather stitches (large machine stitch) 1.2cm and 1.8cm from the folded edge. Starting and finishing at each side seam tailor tack.



*Shown: size 10, 120 wide fabric.*

## MAKE TIES

8. If not using ribbon ties, make 2 ties by cutting 2 pieces of leftover self or lining fabric 52 x 3cm.

Press in 1cm at one short edge.

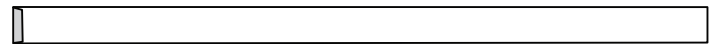

Press the two long edges into the centre, then press in half and stitch down.



## ATTACH RIBBON OR TIES TO BODICE

9. Place tie or ribbon on the BACK LININGS 1.5cm down from top edge. Stitch 1.4cm in from the vertical edge.

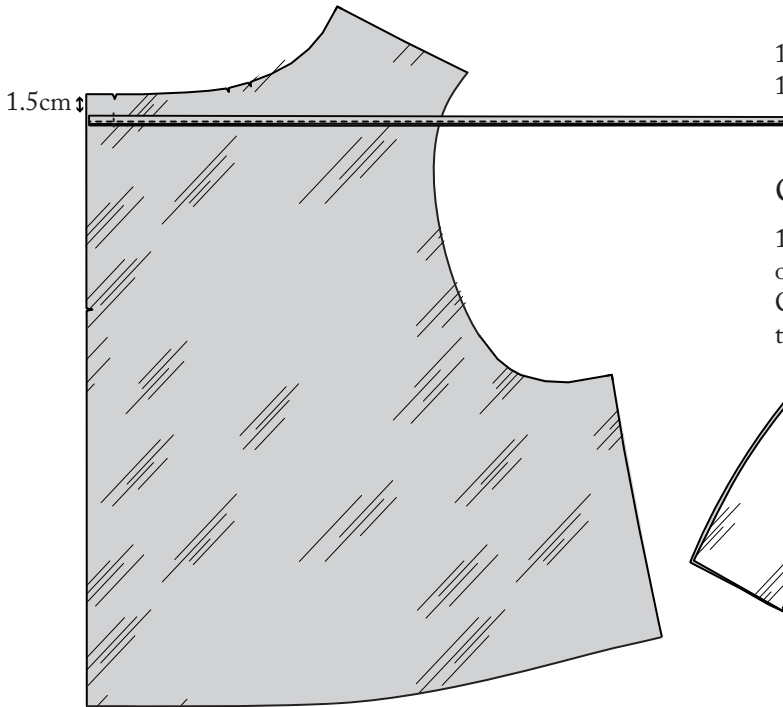

*Shown: size 10*

## SHOULDER, DART (20-28 ONLY) NECK & ARMHOLES

10. Follow Trapeze instructions: Shoulder Seam (step 4 - sizes 8-18) or Dart & shoulder seam (steps 4-5 - sizes 20-28).

11. Follow Trapeze instructions: Facing neck and armholes (steps 18-22), noting that the party dress bodice is fully faced.

## CENTRE BACK OPENING

12. With right sides together, and keeping the ribbons/ties out of the way, stitch back self to back lining together at the CB seam from the neck edge to the notch. Clip corners, turn through and press.

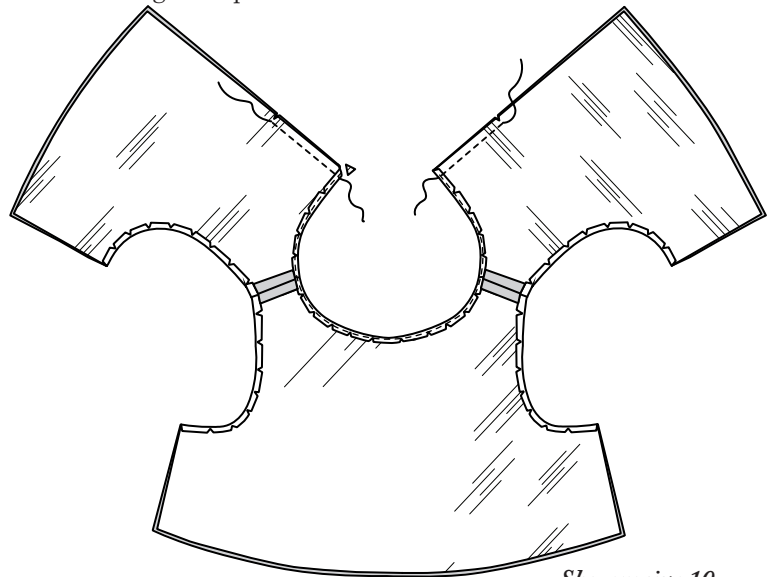

*Shown: size 10*

## CENTRE BACK SEAM

13. With right sides together, stitch centre back seam to notch, carefully moving lining out of the way. Press open.

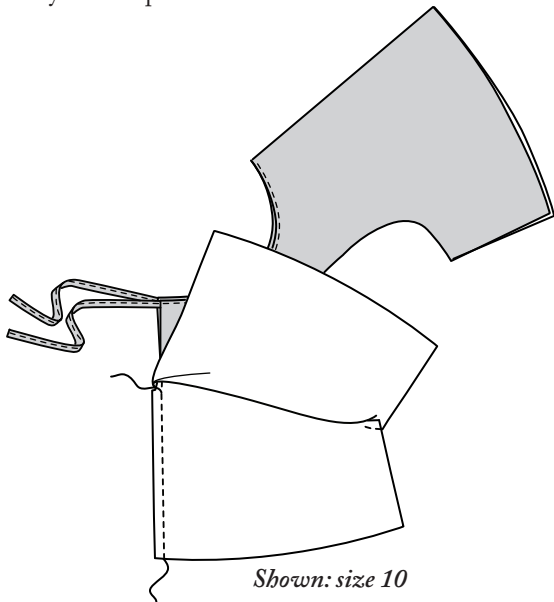

## CENTRE BACK LINING SEAM

14. With right sides together, stitch centre back lining seam as close to the notch as possible, moving self layer out of the way. Press open. Close the gap at the top with a few slip stitches.

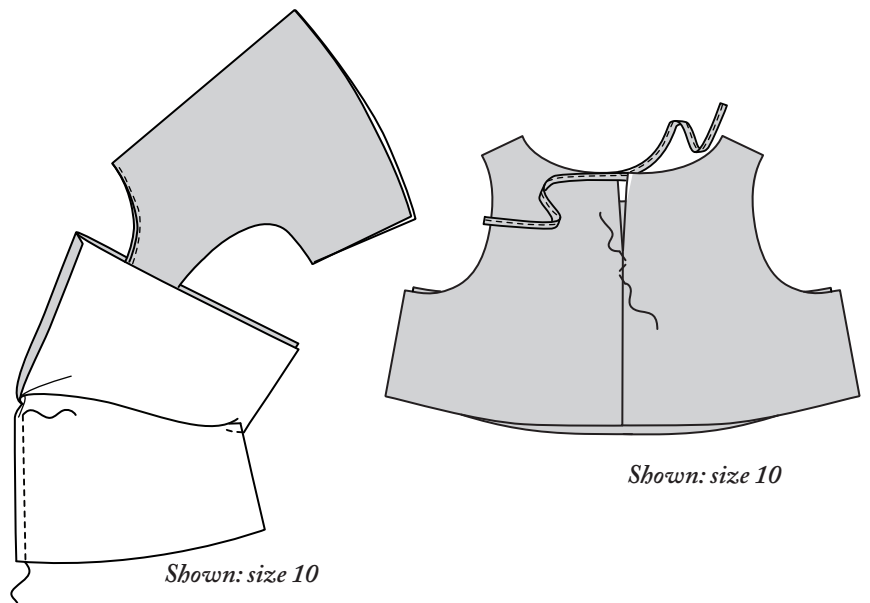

## SIDE SEAMS

15. Follow Trapeze instructions: Side Seams Sleeveless Dress (step 33). There is no need to neaten the seams.

## NEATEN EDGE OF BODICE & MARK CF, SIDES & WAIST

16. Follow Trapeze instructions: Side Seams Sleeveless Dress (step 33). There is no need to neaten the seams. Neaten the self layer to the lining layer with an overlock or zigzag. Mark with chalk or tack line, the skirt position 2.5cm above the bottom edge. Mark the CF position and the distance between the CF and CB (which may not necessarily be the side seam) with chalk, pins or tailor tacks

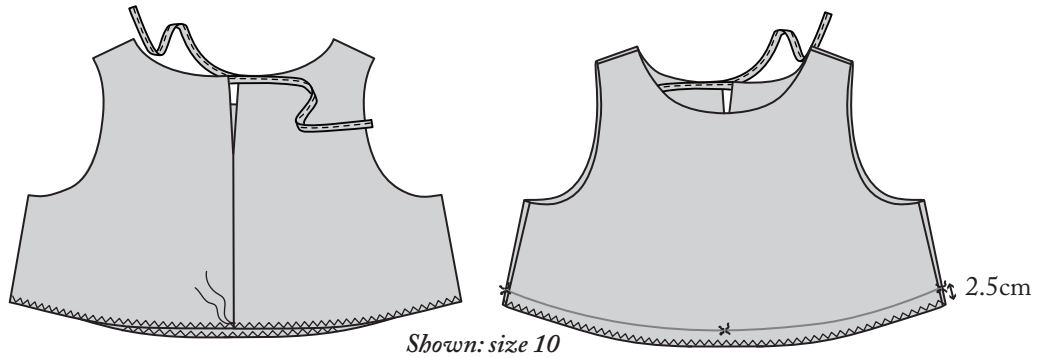

## ATTACH SKIRT

17. Gather in the skirt to the bodice measurement. Leave the gather stitch thread ends loose (these will be sewn into the inside afterwards).

Match the folded edge at the top of the skirt to the marked chalk/tack line, overlapping the skirt over the bodice. Evenly spread gathers across the bodice (matching CF/CB and side tailors tacks). Pin, then stitch onto the bodice in-between the two gather rows, so when complete you will have three lines of stitching visible. Thread the gather threads onto a needle and secure on the inside.

